



Installation and Operating Instructions

IMPORTANT INSTALLATION NOTES!

- * The door must be attached to the opener BEFORE installing the batteries. Do not fit the batteries until the ChickSafe and door are fully installed.
- * The door must be lifted and held in the open position before attaching the cord. The ChickSafe is supplied with the cord wound in ready to be attached to the open door. It will return to this position each time it opens.
- * The door must stop against a solid surface at its closed position. The ChickSafe detects when the weight of the door is no longer being supported on the cord and that lets the control know the door is closed.
- * The distance the door moves between its closed position and open position must be no greater than 400mm (15 inches). If the door moves down through a greater distance the cord will wind back in again and the door will be open even when the ChickSafe shows it is closed (double flashes of the LED light).
- * Do not remove the knot in the cord that was tied there at the factory. This knot operates the sensing device to stop the ChickSafe in the open position.
- * Ensure the maximum door weight of 8lbs (4kg) is not exceeded as this will cause damage to the motor and invalidate the warranty! Note that wooden doors are heavier when wet.
- * Check the sliding door to make sure it runs smoothly and reliably both upwards and downwards. The ChickSafe uses gravity alone to close the door.
- * To mount the ChickSafe further away from the door, an additional length of cord may be attached to the end of the internal cord. Do not wind out any cord from inside the ChickSafe.
- * For helpful information see our ChickSafe 'Frequently Asked Questions' page and installation videos at www.brinsea.com

Please read these instructions carefully before setting up your ChickSafe Advance to achieve best results and keep these instructions safe for future reference.

To register your new Brinsea product and qualify for your free 3 year warranty please visit www.brinsea.com within 30 days of purchase and follow the link on the Brinsea home page. The serial number may be found on the box and inside the battery compartment. Sign up for the Brinsea newsletter to receive the latest news and information.

- * **Warning - Risk of injury! Keep fingers clear of moving door and cord. Motor may start without warning.**
- * This appliance can be used by children aged from 8 years and above and persons with reduced physical, sensory or mental capabilities or lack of experience and knowledge if they have been given supervision or instruction concerning use of the appliance in a safe way and understand the hazards involved. Children shall not play with the appliance. Cleaning and user maintenance shall not be made by children without supervision.

Tools needed for installation:

- Screwdriver (cross head PZ1)
- Drill with a 1/8" (3mm) diameter drill bit, or bradawl
- Tape measure

Caution! - Please Note:

- Use only alkaline AA batteries
- Observe correct polarity to prevent leakage or risk of fire
- Do not mix old and new batteries, replace all 4
- Do not use re-chargeable batteries
- Do not use a 9 volt battery
- Remove the batteries if you do not intend to use the ChickSafe for a long period.

1

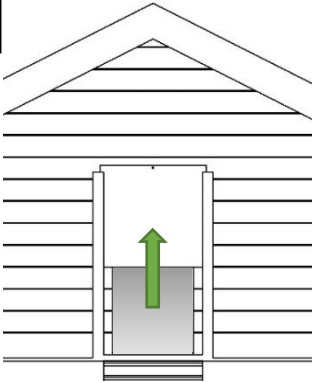

Raise the sliding door to its fully open position.

Support the door in that position.

Once fitted, the ChickSafe will always open the door to this height. Make sure it is correct.

2

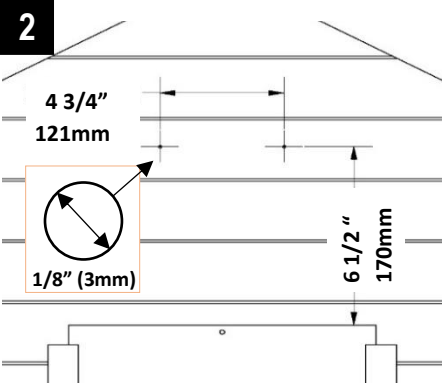

Mark two hole positions 4 3/4" (121mm) apart and approximately 6 1/2" (170mm) above the top of the sliding door.

Make sure they are level and evenly spaced above the centre of the door.

Make the holes with a 1/8" (3.0mm) drill bit or bradawl.

3

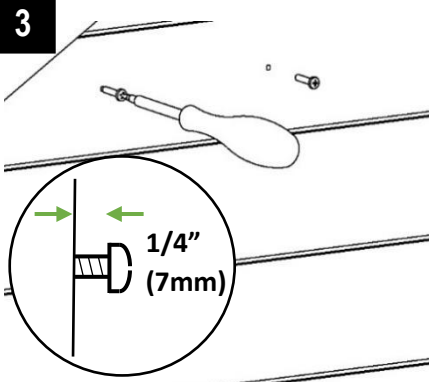

Start to fit the two screws supplied into the holes you have made.

Tighten each screw until its head is 1/4" (7mm) from the surface.

4

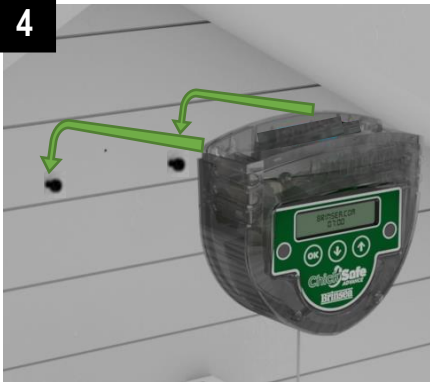

Hang the ChickSafe on the two screws.

Gently tighten each screw to make the ChickSafe secure.

Make sure the ChickSafe remains flat against the fixing surface.

5



Make a hole or fix a ring to the centre of the top of the door as necessary.

Tie the ChickSafe cord to the hole/ring.

Make sure the cord is taut once tied on.

Now allow the door to hang on the cord.

6

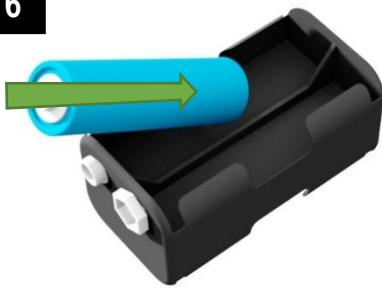

Fit the 4 batteries into the holder.
Check the polarity of each battery!

7



The battery holder fits this way up in the top of the ChickSafe.

8

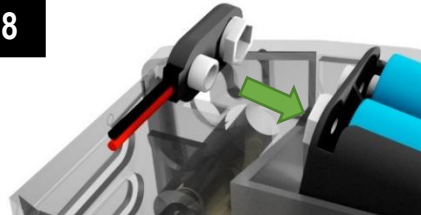

Fit the connector to the battery holder. The motor will operate briefly, then the display should show:

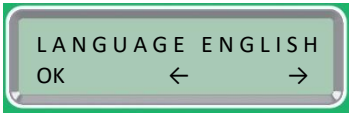

If the display only shows 'RESET' please see page 9 on clearing a blocked door and performing a cord reset.

9



Fit the battery cover over the top.
It pushes down into place.

10



The ChickSafe is now ready to be set up. Read the rest of the instructions carefully to get the most benefit from your ChickSafe.

11

READ THE FOLLOWING PAGES TO UNDERSTAND THE CONTROL FEATURES. SET THE LANGUAGE, TIME AND DAY OF THE WEEK. TEST THE OPEN AND CLOSE FUNCTIONS OF YOUR CHICKSAFE (SEE PAGE 6).

Check operation carefully for the first few days to ensure the installation is successful and the door is operating smoothly.

The red indicator LED provides information on current status.

BASIC FUNCTIONS

Sleep Mode:

The ChickSafe is designed to use as little battery power as possible. It will normally be in **sleep mode** with a blank display and will flash the indicator LED periodically to show its status.

Press  briefly to 'wake' the display and show the current time and battery condition.

The display will go off after 10 seconds to conserve power.

Open Now: Note that this function only works from sleep mode (blank display) to prevent accidental opening

The door may be opened at any time from **sleep mode** (blank display) using an **open now** function:

Press  for **5 seconds** to open the door. The display will wake and the door will start opening. You can now release the key. It will stay open until it is next due to close (as set in **close mode**) but remember to close the door again using a 'Close Now' command if it had already closed that evening.

Close Now: Note that this function only works from sleep mode (blank display) to prevent accidental closing

The door may be closed at any time from **sleep mode** (blank display) using a **close now** function:

Press  for **5 seconds** to close the door. The display will wake and the door will start closing. You can now release the key. It will stay closed until it is next due to open (as set in **open mode**).

Manual Override Mode:

If the automatic system is not required to function for a period of time, all automatic functions may be stopped from **sleep mode** (blank display) using the **manual override mode** function:

Press  for **5 seconds**. The display will state 'MANUAL MODE IS ON!'.

While manual override mode is on, the door may still be opened and closed using **open now** and **close now** functions.

To turn **manual override mode** off and resume normal automatic function:

Press  for **5 seconds**. The display will change from 'MANUAL MODE IS ON!' to 'MANUAL MODE IS OFF'.

Battery Condition Display:

The battery voltage is checked while the door is being opened to give an indication of battery condition:



New batteries



Partially discharged

Replace batteries immediately!
If the status LED is flashing every second the system has detected the batteries will no longer reliably operate the door. It will stay closed.

TIME MENU FUNCTIONS

Setting the language, time and day of the week:

When the batteries are first connected the language, time and day of week must be set:

Press  or  to adjust the time or scroll through options.

Press  to move to the next screen.

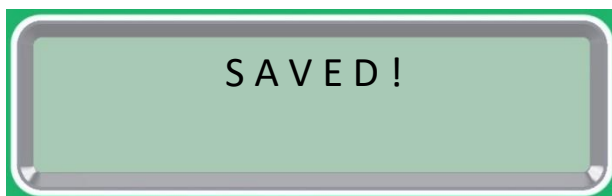
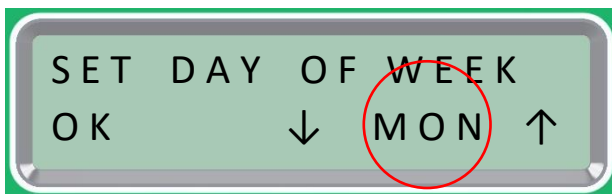
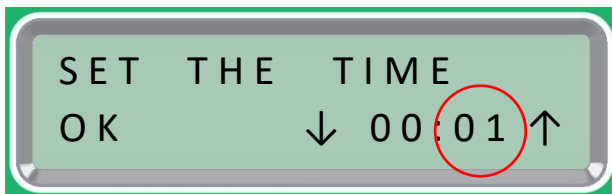
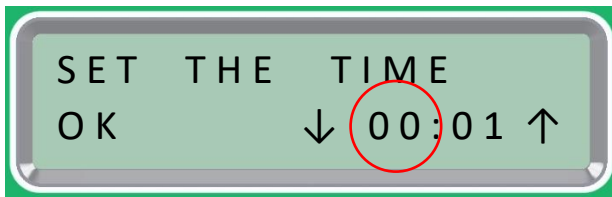
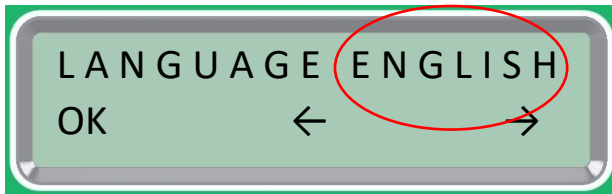

Power-Up screen.
The ChickSafe will automatically detect the door position. Please wait...



Select the language:
Options: English, French, Spanish.

Set the current time:
Hours.

Set the current time:
Minutes.

Set the day of the week:
Options: Mon, Tue, Wed, Thu, Fri, Sat, Sun.

The settings are automatically saved.
Note: If the battery has been removed or discharged these settings will need to be updated again before the system will operate.

Press  +  +  together to change the above settings at any time.

TESTING THE MOVEMENT OF THE DOOR

Note that the **open now** and **close now** functions only operate from **sleep mode** (blank display) and must be pressed for **5 seconds** which helps prevent accidental operation. To test the door operation:

From sleep mode, press and hold  for **5 seconds**. The door will close. The motor should stop as the door lands on the flat surface at the bottom of the pop hole. If it stops sooner, the door is getting stuck in its runners.

From sleep mode, press and hold  for **5 seconds**. The door will open. The motor should stop as the door reaches its fully open position, where it was held open during installation.

To test the light sensing function:

The main menu settings must still be set as their default values with both **open mode** and **close mode** set to **light**.

Cover the ChickSafe with a dark cloth or box. It must be very dark under the cover. The door will close after approximately 6 minutes. Remove the cloth or box. The door will open after approximately 6 minutes.

MAIN MENU FUNCTIONS

Open Mode:

Select to open the door according to:

Light – the door will open as it gets light.

Time – the door will open at the set time.

Manual – the door will only open when you press 

Open Delay:

If **open mode** is set to **light** the **open delay** will open the door 0, 1, 2 or 3 hours after it gets light. This can be useful in the summer months when it gets light very early. A different delay may be set for the weekend (Saturday and Sunday) to allow a later opening of the door on those days.

If **open mode** is set to **time** the **open delay** will open the door 0, 1, 2 or 3 hours after the set time. A different delay may be set for the weekend (Saturday and Sunday) to allow a later opening of the door on those days.

Close Mode:

Select to close the door according to:

Light – the door will close as it gets dark.

Time – the door will close at the set time.

Light + Time – the door will close as it gets dark, but no later than the set time.



Manual – the door will only close when you press 



Closing Light Level:

The closing light level at dusk may vary with location and how the sunlight falls on the ChickSafe. The light level that makes the door close may be adjusted between 0 and 255 where 0 is complete darkness. The default number is 50 and suitable for most locations.

Setting the open modes, close modes and light sensitivity

Press  to wake the display.

Press  +  together to open the menu.

Press  or  to adjust the time or scroll through options.

Press  to move to the next screen.

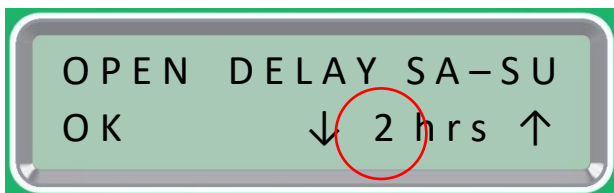
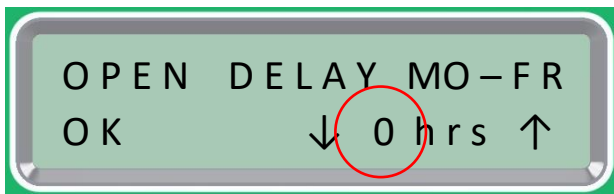
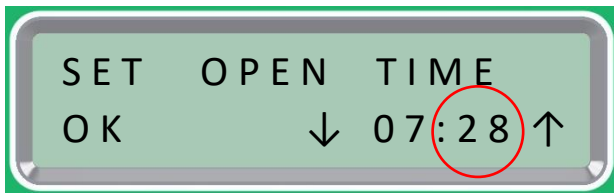
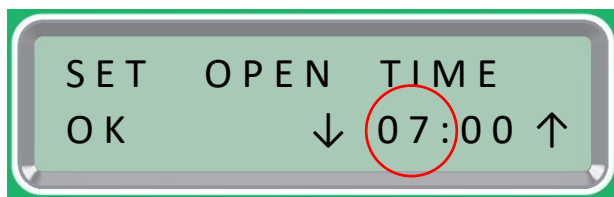
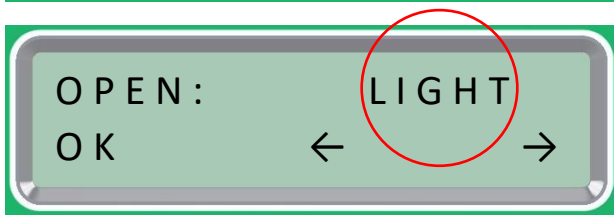

Press  to wake the Power-Up screen.

Press  +  to open the menu.

Select the **open mode**. Choose from:

LIGHT: Open when it gets light.

TIME: Open at the time you set.

MANUAL: The door will stay closed until you press:  to open it whenever you want to.

Set the **open time** (hour):

The door will open at this time if the open mode is set to TIME.

Ignore if open mode is set to Light or Manual.

Set the **open time** (minutes):

The door will open at this time if the open mode is set to TIME.

Ignore if open mode is set to Light or Manual.

Set the **open delay** (Monday to Friday):

This delays the door opening by 0 – 3 hours from when it gets light (or from the set open time above).

Set the **open delay** (Saturday and Sunday):

This delays the door opening by 0 – 3 hours from when it gets light (or from the set open time above). This allows you to choose a different opening time at the weekend.

Continued on next page...

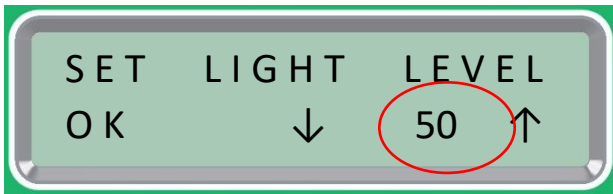
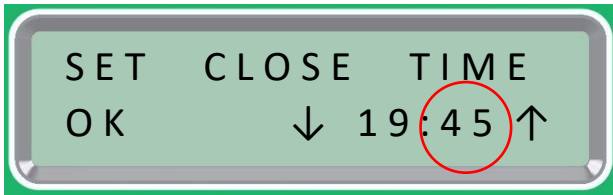
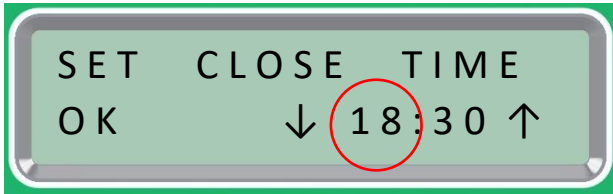
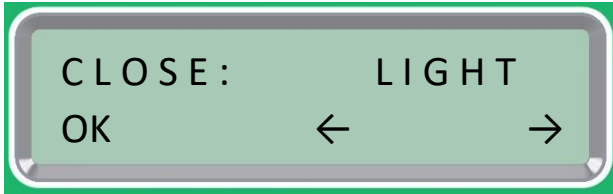



Select the **close mode**. Choose from:
 LIGHT: Close when it gets dark.
 TIME: Close at the time you set.
 LIGHT+TIME: Close when it gets dark, or no later than the set time.
 MANUAL: The door will stay open until you press:  to close it whenever you want to.

Set the **close time** (hour):
 The door will close at this time if the close mode is set to TIME, or no later than this time if set to LIGHT+TIME and it is not yet dark.
Ignore if close mode is set to Light or Manual.

Set the **close time** (minutes):
 The door will close at this time if the close mode is set to TIME, or no later than this time if set to LIGHT+TIME and it is not yet dark.
Ignore if close mode is set to Light or Manual.





Set the **closing light level**:
 Closing light levels at dusk vary with location and direction of installation. The light level that makes the door close may be adjusted from 0 (complete darkness) to 255. The default is 50.

Save or reject changes:
 Press  to SAVE the new settings.
 Press  to reject any changes.

Changes have been saved. These settings are stored even if the battery is removed or discharged.

LED STATUS INDICATOR



-  Single flash every 30 seconds – Door is open
-  Double flash every 30 seconds – Door is closed
-  Single flash every 10 seconds – Door is open, replace batteries soon!
-  Double flash every 10 seconds – Door is closed, replace batteries soon!
-  Single flash every second – Door is stuck or batteries too discharged to open the door. Investigate cause!

Cleaning:

Disconnect the battery holder before cleaning the ChickSafe Advance.
Keep the battery holder and electrical connections dry at all times.
Do not immerse the ChickSafe Advance in water.
Wipe surfaces clean with a damp cloth and mild detergent as necessary.

Clearing A Blocked Door Error:

The ChickSafe monitors door movement and if it appears the door has become blocked /stuck the system will stop the motor to help prevent damage and will flash the status LED every second to warn the door may not be closed.



Press  to wake the display. If the blocked door system has been activated one of the following is shown:



This screen shows during setup if the system detects an error after the batteries are connected for the first time.



This screen indicates a blocked door some time after the initial installation.

Check the door is still attached to the cord and is free to move upwards and downwards freely. Once the door is free to move correctly wake the display by pressing  and then press  to reset the system.

If the cord has become detached from the door, perform a cord reset as described below and then attach the cord to the door by following the instructions on page 2.

Reset:

If the batteries have been connected before the door is installed, or if the cord has become detached from the door, it may be necessary to reset the system:

- a. The ChickSafe must be upright, in its installed position.
- b. Disconnect the battery holder connector.
- c. Wait 1 minute.
- d. Gently pull the end of the cord down and keep gently pulling during the next few steps. It is important to maintain some tension on the cord.
- e. While pulling, refit the battery holder connector and still keep pulling gently.
- f. Maintain tension on the cord. After 10 seconds the cord will be wound out for a second and then start to wind in. Keep maintaining tension on the cord all the time until the motor stops.
- g. Release the cord.
- h. Disconnect the battery holder.
- i. Reattach the cord to the door in its open position. Follow the installation instructions from the start to ensure the door opens to the correct position.
- j. Reconnect the battery holder.

The system is now reset to the factory position. For helpful information see our ChickSafe 'Frequently Asked Questions' page at www.brinsea.com

Automatic openers and accessories are intended to help keep chickens safe but the overall responsibility for the welfare and safety of livestock remains with the owner/keeper. Brinsea, its retailers or distributors will not be responsible for the loss of livestock or consequential loss in the event of failure however caused.

Product Dimensions:

Height 5.9" (150mm)

Width 5.9" (150mm)

Depth 3.0" (75mm)

Weight 13oz (375g)

Brinsea Products Inc., 704 N Dixie Ave., Titusville, FL 32796-2017 USA.

Phone. (321) 267-7009 Toll Free 1-888-667-7009 Fax (321) 267-6090

e-mail Sales@Brinsea.com, website www.Brinsea.com