

# **Brinsea**



## **Installation and Operating Instructions**

### **IMPORTANT INSTALLATION NOTES!**

- \* The door must be attached to the opener BEFORE installing the batteries. Do not fit the batteries until the ChickSafe and door are fully installed.
- \* The door must be lifted and held in the open position before attaching the cord. The ChickSafe is supplied with the cord wound in ready to be attached to the open door. It will return to this position each time it opens.
- \* The door must stop against a solid surface at its closed position. The ChickSafe detects when the weight of the door is no longer being supported on the cord and that lets the control know the door is closed.
- \* The distance the door moves between its closed position and open position must be no greater than 400mm (15 inches). If the door moves down through a greater distance the cord will wind back in again and the door will be open even when the ChickSafe shows it is closed (double flashes of the LED light).
- \* Do not remove the knot in the cord that was tied there at the factory. This knot operates the sensing device to stop the ChickSafe in the open position.
- \* Ensure the maximum door weight of 8lbs (4kg) is not exceeded as this will cause damage to the motor and invalidate the warranty! Note that wooden doors are heavier when wet.
- \* Check the sliding door to make sure it runs smoothly and reliably both upwards and downwards. The ChickSafe uses gravity alone to close the door.
- \* To mount the ChickSafe further away from the door, an additional length of cord may be attached to the end of the internal cord. Do not wind out any cord from inside the ChickSafe.
- \* For helpful information see our ChickSafe 'Frequently Asked Questions' page and installation videos at [www.brinsea.com](http://www.brinsea.com)

Please read these instructions carefully before setting up your ChickSafe Eco to achieve best results and keep these instructions safe for future reference.

To register your new Brinsea product and qualify for your free 3 year warranty please visit [www.brinsea.com](http://www.brinsea.com) within 30 days of purchase and follow the link on the Brinsea home page. The serial number may be found on the box and inside the battery compartment. Sign up for the Brinsea newsletter to receive the latest news and information.

- \* **Warning - Risk of injury! Keep fingers clear of moving door and cord. Motor may start without warning.**
- \* **This appliance can be used by children aged from 8 years and above and persons with reduced physical, sensory or mental capabilities or lack of experience and knowledge if they have been given supervision or instruction concerning use of the appliance in a safe way and understand the hazards involved. Children shall not play with the appliance. Cleaning and user maintenance shall not be made by children without supervision.**

**Tools needed for installation:**

- Screwdriver (cross head PZ1)
- Drill with a 1/8" (3mm) diameter drill bit, or bradawl
- Tape measure

**Caution! - Please Note:**

- Use only alkaline AA batteries
- Observe correct polarity to prevent leakage or risk of fire
- Do not mix old and new batteries
- Do not use re-chargeable batteries
- Do not use a 9 volt battery
- Remove the batteries if you do not intend to use the ChickSafe Eco for a long period.

1

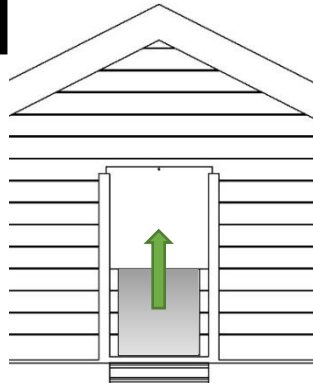

Raise the sliding door to its fully open position.

Support the door in that position.

Once fitted, the ChickSafe will always open the door to this height. Make sure it is correct.

2

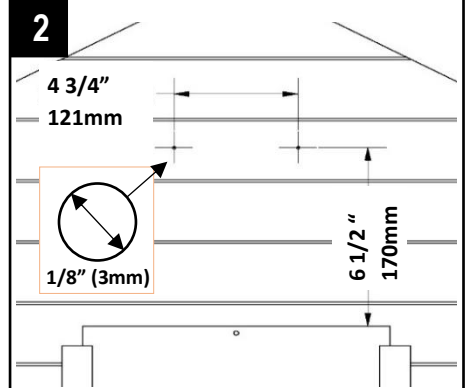

Mark two hole positions 4 3/4" (121mm) apart and approximately 6 1/2" (170mm) above the top of the sliding door.

Make sure they are level and evenly spaced above the centre of the door.

Make the holes with a 1/8" (3.0mm) drill bit or bradawl.

3

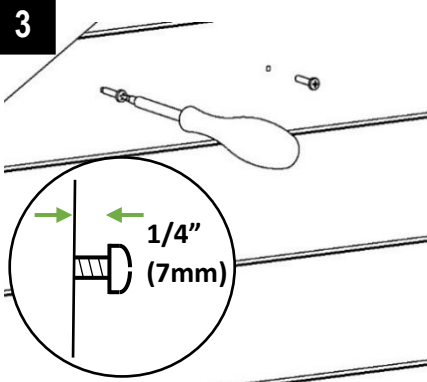

Start to fit the two screws supplied into the holes you have made.

Tighten each screw until its head is 1/4" (7mm) from the surface.

4



Hang the ChickSafe on the two screws.

Gently tighten each screw to make the ChickSafe secure.

Make sure the ChickSafe remains flat against the fixing surface.

5



Make a hole or fix a ring to the centre of the top of the door as necessary.

Tie the ChickSafe cord to the hole/ring.

Make sure the cord is taut once tied on.

Now allow the door to hang on the cord.

6

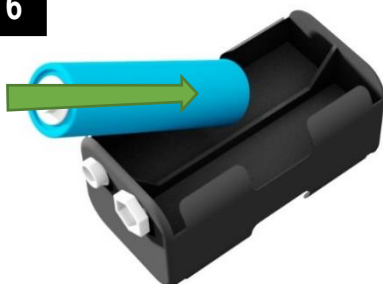

Fit the batteries into the holder. Check the polarity of each battery!

7

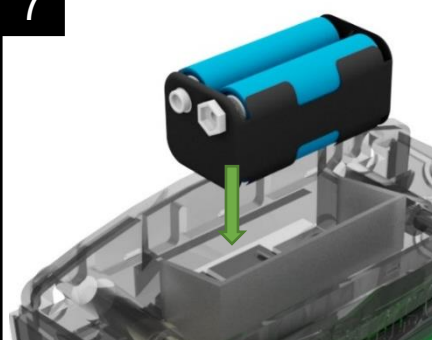

The battery holder fits this way up in the top of the ChickSafe.

8

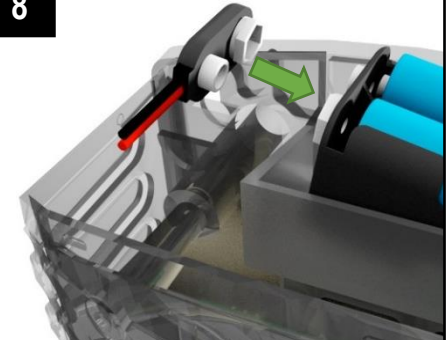

Fit the connector to the battery holder.

After 10 seconds the motor will operate briefly.

**9**



Fit the battery cover over the top.  
It pushes down into place.

**10**



The ChickSafe is now ready!  
The door will be opened or closed according to daylight.

**11**

**TESTING THE MOVEMENT OF THE DOOR**





Cover the ChickSafe with a dark cloth or box. It must be very dark under the cover.

The door will close after approximately 6 minutes.

Remove the cloth or box. The door will open after approximately 6 minutes.

Check operation carefully for the first few days to ensure the installation is successful and the door is operating smoothly. The red indicator LED provides information on current status. Please continue reading for more information!



-  Single flash every 30 seconds – Door is open
-  Double flash every 30 seconds – Door is closed
-  Single flash every 10 seconds – Door is open, replace batteries soon!
-  Double flash every 10 seconds – Door is closed, replace batteries soon!
-  Single flash every second – Door is stuck or batteries too discharged to open the door. Investigate cause!

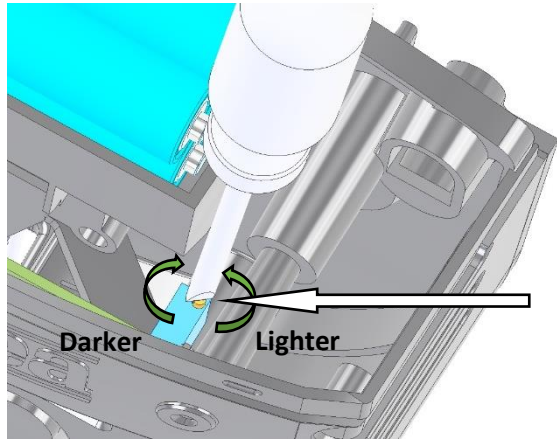

**Closing Light Level Adjustment**

Closing light levels at dusk vary with location and direction of installation. The light level that makes the door close may be adjusted:

360 degree turn clockwise to decrease light level (darker).  
360 degree turn anti-clockwise to increase light level (lighter).  
(Use a small, flat precision-screwdriver).

Adjust by one turn at a time. The adjustment range from the factory setting is approximately 5 turns darker (clockwise), 15 turns lighter (anti-clockwise). Adjusting further than this range has no effect.

**Cleaning:**

Disconnect the battery holder before cleaning the ChickSafe Eco.  
Keep the battery holder and electrical connections dry at all times.  
Do not immerse the ChickSafe Eco in water.  
Wipe surfaces clean with a damp cloth and mild detergent as necessary.

**Reset:**

If the batteries have been connected before the door is installed, or if the cord has become detached from the door, it may be necessary to reset the system:

- a. The ChickSafe must be upright, in its installed position.
- b. Disconnect the battery holder connector.
- c. Wait 1 minute.
- d. Gently pull the end of the cord down and keep gently pulling during the next few steps. It is important to maintain some tension on the cord.
- e. While pulling, refit the battery holder connector and still keep pulling gently.
- f. Maintain tension on the cord. After 10 seconds the cord will be wound out for a second and then start to wind in. Keep maintaining tension on the cord all the time until the motor stops.
- g. Release the cord.
- h. Disconnect the battery holder.
- i. Reattach the cord to the door in its open position. Follow the installation instructions from the start to ensure the door opens to the correct position.
- j. Reconnect the battery holder.

The system is now reset to the factory position. For helpful information see our ChickSafe 'Frequently Asked Questions' page at [www.brinsea.com](http://www.brinsea.com)

Automatic openers and accessories are intended to help keep chickens safe but the overall responsibility for the welfare and safety of livestock remains with the owner/keeper. Brinsea, its retailers or distributors will not be responsible for the loss of livestock or consequential loss in the event of failure however caused.

**Product Dimensions:**

Height 5.9" (150mm)

Width 5.9" (150mm)

Depth 3.0" (75mm)

Weight 13oz (375g)

**Brinsea Products Inc., 704 N Dixie Ave., Titusville, FL 32796-2017 USA.**

**Phone. (321) 267-7009 Toll Free 1-888-667-7009 Fax (321) 267-6090**

**e-mail [Sales@Brinsea.com](mailto:Sales@Brinsea.com), website [www.Brinsea.com](http://www.Brinsea.com)**